



ZenAluminium

PREMIUM LINE



MANUFACTURER OF DOOR INFILL PANELS



**ZenAluminium**

WITH A PASSION FOR DOORS

## TOGETHER WE CAN ACHIEVE MORE

Dindecor designs and manufactures high-quality door fillings that match your vision and needs. The infill panels that we make lend an exceptional character to the doors they are fitted in, Doors are not merely an entrance to your home, but also a calling card, an expression of individuality and personal aesthetics. Every day, we strive to meet our partners' expectations by producing doors in line with the customer's vision and with attention to the smallest details.

## YOU CAN ONLY ACHIEVE THE HIGHEST QUALITY BY USING THE LATEST TECHNOLOGIES

Dindecor manufactures door infill panels using the latest technologies. Our advanced machine park, including CNC cutters and a state-of-the-art powder coating paint facility mean that we can offer top quality products. Of course this wouldn't be possible without our qualified staff, who guarantee attention to every detail and an aesthetically satisfying final result. Because we also do hand-finished work, the customer can freely choose from among various designs, decorative applications, glazings and many other materials, to make the doors they choose exceptional.

We present to you the Premium+ line, including a range of new designs and materials that have never been included in our offer before. The offer was created based on the demands of our customers as well as the latest market trends.

A new element of the offer is infill panels with natural stone, concrete, or toughened black glass. Furthermore, the Inox inlay can now be replaced with a 3D decorative application. The offer also now includes painted inlaid handles in colours that match the infill panel.



STONELINE

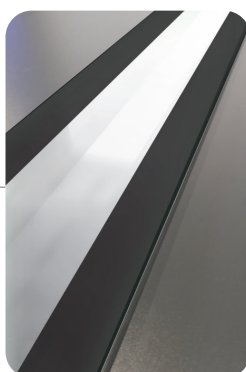

GLASSLINE



RETROLINE

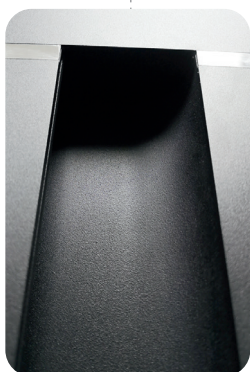

INTEGRATED  
INSET HANDLE



CONCRETE  
EFFECT

In selected models, flush or protruding stainless steel decorative applications are available



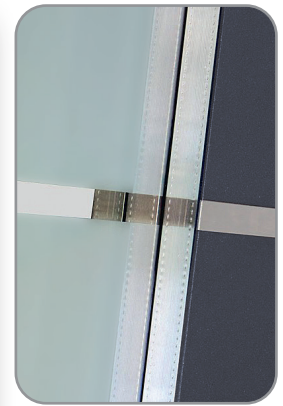

## MODEL 2802

Colour: RAL7016  
 Glazing: Sand-etched as shown in design  
 Decorative applications:  
 Stainless steel, flush with surface  
 Handle: PD134 - 1600mm, oak wood



Flush or 3D  
 applications



## MODEL 2802 WD

Colour: RAL7016 / Woodec veneer  
 Glazing: Sand-etched as shown in design  
 Decorative applications:  
 Stainless steel, flush with surface  
 Handle: PS10, L-1600mm



## MODEL 2802 BS

Colour: RAL7004 / metal  
 painted to any RAL colour  
 Glazing: Sand-etched  
 as shown in design  
 Decorative applications:  
 Stainless steel, flush with surface  
 Handle: PS10, L-1600mm



## MODEL 2802 FR

Colour: RAL7001  
 Glazing: Sand-etched  
 as shown in design  
 Decorative applications: Routing  
 Handle: PD134 - 1600mm, oak wood

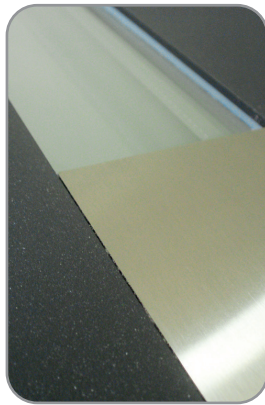

MODEL 1301

Colour: RAL7016  
 Glazing: Satinovo  
 Decorative applications:  
 Stainless steel, flush with surface  
 Handle: PS10 - 1600mm

MODEL 1101

Colour: RAL7016  
 Glazing: Satinovo  
 Handle: PS10 - 1600mm



MODEL 6002

Colour: RAL9016  
 Glazing: Satinovo  
 Decorative applications:  
 Stainless steel, flush with surface  
 Handle: PS10 - 1200mm

MODEL 1401

Colour: RAL7016  
 Glazing: Satinovo  
 Decorative applications:  
 Stainless steel, flush with surface  
 Handle: PS10 - 1600mm

MODEL 5022

Colour: RAL7016  
 Glazing: Satinovo  
 Handle: PS10 - 1200mm



Flush or 3D applications

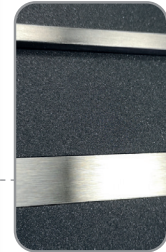

## MODEL 5026

Colour: RAL7016  
 Glazing: Satinovo  
 Decorative applications:  
 Stainless steel, flush with surface  
 Handle: PS – 1400mm



Flush or 3D applications

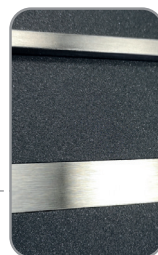

## MODEL 5026 WD

Colour: RAL9016 / Woodec veneer  
 Glazing: Satinovo  
 Decorative applications:  
 Stainless steel, flush with surface  
 Handle: PS – 1400mm



## MODEL 5026 BS

Colour: RAL7016 / metal painted to any RAL colour  
 Glazing: Satinovo  
 Decorative applications:  
 Stainless steel, flush with surface  
 Handle: PS – 1400mm



MODEL 2801

Colour: RAL7016  
 Decorative applications: Routing  
 Handle: PD134 – 1600mm,  
 jatoba wood

Flush or 3D  
 applications

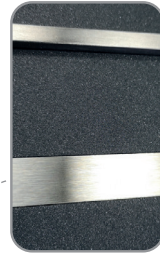

MODEL 2801 ST

Colour: RAL7016  
 Decorative applications:  
 Stainless steel, flush with surface  
 Handle: PQ 40x20 L-1600mm



Flush or 3D  
 applications

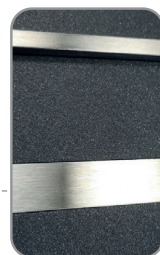

MODEL 2801 BS

Colour: RAL9016 / metal painted  
 to any RAL colour  
 Decorative applications:  
 Stainless steel, flush with surface  
 Handle: PQ 40x20 L-1600mm



PREMIUM LINE



MODEL 5009

MODEL 6111

Colour: RAL7016  
 Decorative applications: Routing  
 Handle: PS10 – 1200mm

Colour: RAL 9016  
 Decorative applications: Routing  
 Handle: PQ10 – 800mm painted with RAL 9005



Flush or 3D applications



MODEL 5009 ST

MODEL 5018

MODEL 5014

Colour: RAL7016  
 Decorative applications: Stainless steel, flush with surface  
 Handle: PS10 – 1200mm

Colour: RAL7016  
 Decorative applications: Stainless steel, flush with surface  
 Handle: PW10

Colour: RAL 7004  
 Decorative applications: Routing  
 Handle: PW21







MODEL 5008

Colour: RAL7016  
 Glazing: Satinovo  
 Decorative applications:  
 Stainless steel, flush with surface  
 Handle: PS10 – 1200mm



MODEL 5008

Colour: RAL9007  
 Glazing: Satinovo  
 Decorative applications:  
 Flush with Montana veneer  
 Handle: PS10 – 1200mm





Flush or 3D applications

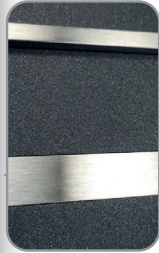

MODEL 5007 ST

Colour: RAL7016  
 Glazing: Satinovo  
 Decorative applications:  
 Stainless steel, flush with surface  
 Handle: PS10 – 1400mm



MODEL 5007

Colour: RAL7016  
 Glazing: Satinovo  
 Decorative applications: Routing  
 Handle: PS10 – 1400mm



MODEL 2901

Colour: RAL7016  
 Glazing: Satinovo  
 Decorative applications: Routing  
 Handle: PS – 800mm



Flush or 3D applications



MODEL 5031 ST

Colour: RAL 7021  
 Glazing: Satinovo  
 Decorative applications:  
 Stainless steel, flush with surface  
 Handle: PS10 – 1200mm

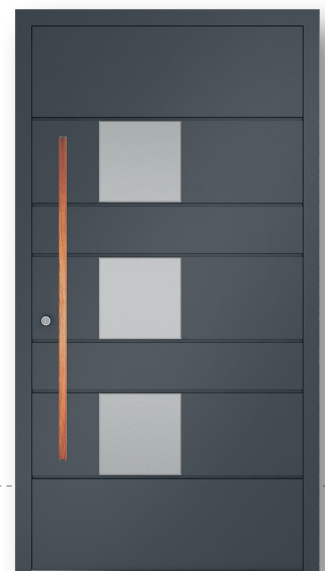

MODEL 5031

Colour: RAL 7016  
 Glazing: Satinovo  
 Decorative applications: Routing  
 Handle: PD136 – 1200mm,  
 jatoba wood



MODEL 5015

Colour: RAL3005  
Handle: PS10 – 1800mm



MODEL 5038

Colour: RAL7016  
Glazing: Sand-etched as shown in design  
Decorative applications: Stainless steel, flush with surface  
Handle: PS10 – 1000mm



MODEL 5046

Colour: RAL7016  
Glazing: Satinovo  
Decorative applications: Stainless steel, flush with surface  
Handle: PS10 – 1000mm

Flush or 3D applications



MODEL 5046 FR

Colour: RAL 7004  
Glazing: Satinovo  
Decorative applications: Routing  
Handle: PS10 – 1000mm



MODEL 5004

Colour: RA7016  
 Decorative applications: Stainless steel,  
 flush with surface, Routing  
 Handle: PS10 – 1200mm

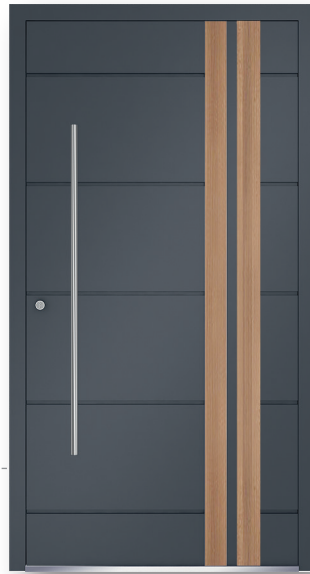

MODEL 5004

Colour: RA7016  
 Decorative applications: Flush  
 with Montana veneer, Routing  
 Handle: PS10 – 1200mm



MODEL 5017

Colour: RAL3003  
 Decorative applications: Routing  
 Handle: PW25



MODEL 5011

Colour: RAL7001  
 Decorative applications: Routing  
 Handle: PW104



MODEL 1701

Colour: RAL7016  
 Glazing: Satinovo  
 Decorative applications:  
 Stainless steel, flush with surface  
 Handle: PS10 – 800mm



MODEL 1702

Colour: RAL7016  
 Glazing: Satinovo  
 Handle: PS10 – 800mm



MODEL 5019

Colour: RAL7001  
 Glazing: Sand-etched  
 as shown in design  
 Handle: PS10 – 800mm



MODEL 2201

Colour: RAL7016  
 Glazing: Satinovo  
 Decorative applications:  
 Stainless steel, flush with surface  
 Handle: PS20 – 850mm



MODEL 6010

Colour: RAL 9016  
 Glazing: Satinovo  
 Decorative applications:  
 Stainless steel, flush with surface  
 Handle: PS10 – 800mm



MODEL 6015

Colour: RAL 3004  
 Glazing: Satinovo  
 Handle: PS10 – 800mm



Flush or 3D applications



### MODEL 6100

Colour: RAL 7016  
 Glazing: Sand-etched as shown in design  
 Decorative applications:  
 Stainless steel, flush with surface  
 Handle: PQ 40x20 L-1600mm

### MODEL 6101

Colour: RAL 7001  
 Glazing: Sand-etched as shown in design  
 Decorative applications: Stainless steel, flush with surface, Routing  
 Handle: PQ 40x20 L-1600mm



Flush or 3D applications



### MODEL 6102

Colour: RAL 7016  
 Glazing: Satinovo  
 Decorative applications:  
 Stainless steel, flush with surface  
 Handle: PS10 L-1200mm



### MODEL 6102 FR

Colour: RAL 7016  
 Glazing: Satinovo  
 Decorative applications:  
 Routing  
 Handle: PS10 L-1200mm



### MODEL 6103

Colour: RAL 9016  
 Glazing: Satinovo  
 Decorative applications: Stainless steel, flush with surface, Routing  
 Handle: PQ 40x20 L-1400mm





MODEL 5040

Colour: RAL 7016  
 Glazing: Satinovo  
 Decorative applications: Stainless steel,  
 flush with surface, Routing  
 Handle: PS 20 – 900mm



MODEL 5006

Colour: RAL 7016  
 Glazing: Satinovo  
 Decorative applications: Routing  
 Handle: PS 20 – 1000mm



MODEL 5001

Colour: RAL 9007  
 Decorative applications: Routing  
 Handle: PS 20 – 850mm



MODEL 5032

Colour: RAL 7016  
 Glazing: Satinovo  
 Decorative applications: Routing  
 Handle: PS 10 – 1200mm



MODEL 6008

Colour: RAL 9016  
 Glazing: Sand-etched  
 as shown in design  
 Decorative applications:  
 Stainless steel, flush with surface  
 Handle: PS 10 – 1200mm

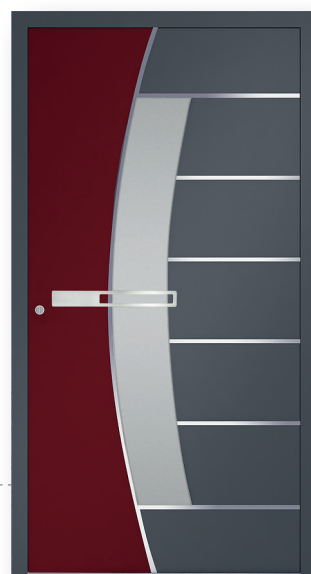

MODEL 5010 BS

Colour: RAL 3004/ RAL7016  
 Glazing: Satinovo  
 Decorative applications:  
 Stainless steel, flush with surface  
 Handle: PZ 76



MODEL 5010

Colour: RAL 7016  
 Glazing: Sand-etched  
 as shown in design  
 Decorative applications:  
 Stainless steel, flush with surface  
 Handle: PS20



MODEL 6104

Colour: RAL 7004/ RAL 9007  
 Decorative applications: Routing  
 Handle: PW 22



MODEL 6105

Colour: RAL 7004 / RAL 9016  
 Glazing: Sand-etched  
 as shown in design  
 Decorative applications: Routing  
 Handle: PQ10, 40x20, L-1200mm



MODEL 5045

Colour: RAL 7016  
 Glazing: Satinovo  
 Decorative applications:  
 Stainless steel, flush with surface  
 Handle: PQ10 40x20 - 1000mm



MODEL 6106

Colour: RAL 7004  
 Glazing: Sand-etched  
 as shown in design  
 Handle: PQ10 40x20 - 1600mm



MODEL 5042

Colour: RAL 9007  
 Glazing: Satin background,  
 sand-etched as shown in design,  
 coloured stick-on applications,  
 glass decorative applications  
 Handle: PS10, 1200mm



MODEL 5041

Colour: RAL 9010  
 Glazing: Sand-etched background, design  
 formed from different types of matte,  
 original Swarovski crystals embedded  
 Handle: PZ 29

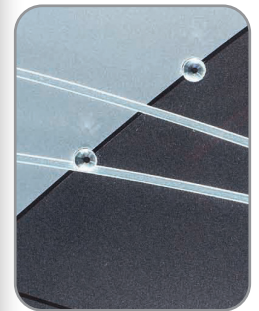



### MODEL 6123

Colour: RAL 7016 / Decoral®  
 Winchester heat-transfer film  
 Decorative applications: Routing  
 Handle: PQ10 40x20 - 1600mm  
 painted with RAL 9005

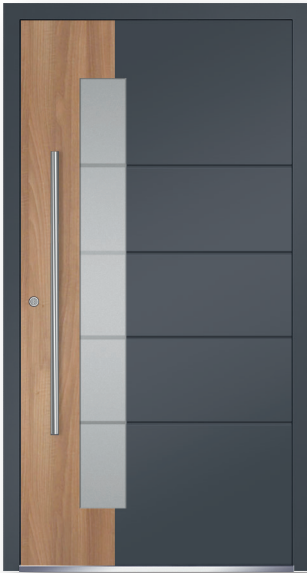

Flush or 3D  
 applications

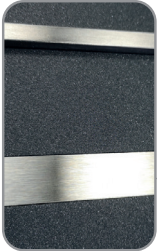

### MODEL 6107

Colour: RAL 7016 / Montana veneer  
 Glazing: Sand-etched as shown in design  
 Decorative applications: Routing  
 Handle: PS10 - 1000mm

### MODEL 6108

Colour: RAL 7016 / Golden Oak veneer  
 Decorative applications: 3D stainless steel  
 Handle: PQ10 40x20 - 1600mm

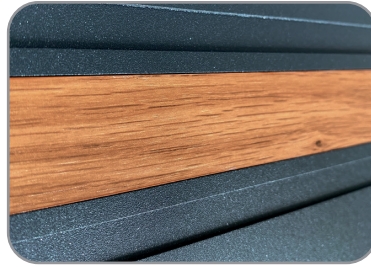

### MODEL 6110

Colour: RAL 9007 /Montana veneer  
Glazing: Sand-etched as shown in design  
Handle: PS10 - 1200mm

### MODEL 6122

Colour: RAL 7016  
Decorative applications: Flush with Woodec veneer, Routing  
Handle: PQ10- 800mm painted with RAL 9005



### MODEL 5015

Colour: Decoral® Winchester heat-transfer film  
Handle: PQ10 -1600mm painted with RAL 9005





## MODEL 6112

Colour: RAL 9016  
 Glazing: Sand-etched as shown in design  
 Decorative applications: Stainless steel,  
 flush with surface, Routing  
 Handle: PS 10D – 1200mm



## MODEL 6112 BS

Colour: RAL 9016 / Metal painted to any RAL colour  
 Glazing: Sand-etched as shown in design  
 Decorative applications: Routing  
 Handle: PS 10 – 1200mm



## MODEL 6112 WD

Colour: RAL 9016 / Woodec veneer  
 Glazing: Sand-etched as shown in design  
 Decorative applications: Routing  
 Handle: PS 10D – 1200mm



MODEL 6113 BS

Colour: RAL 9016 / Metal  
 painted to any RAL colour  
 Glazing: Sand-etched as shown in design  
 Decorative applications: Routing  
 Handle: PS 10 – 1200mm

MODEL 6113 WD

Colour: RAL 9016 / Woodec veneer  
 Glazing: Sand-etched as shown in design  
 Decorative applications: Routing  
 Handle: PS 10 – 1200mm



MODEL 6114

Colour: RAL 7035 / Metal  
 painted to any RAL colour  
 Glazing: Sand-etched as shown in design  
 Decorative applications: Routing  
 Handle: PS 10 – 1200mm

MODEL 6109 BS

Colour: RAL 9016 / Metal  
 painted to any RAL colour  
 Glazing: Sand-etched as shown in design  
 Decorative applications: Routing  
 Handle: PS 10 – 1400 mm

MODEL 6109

Colour: RAL 9016 / Tima veneer  
 Glazing: Sand-etched  
 as shown in design  
 Decorative applications: Routing  
 Handle: PS 10 – 1400mm



## MODEL GL 01

Colour: RAL 9016  
Glazing: Satinovo  
Decorative applications: Black glass  
Handle: PQ10 40x20 -1600mm  
painted with RAL 9005

## MODEL GL 02

Colour: RAL 7016  
Glazing: Sand-etched as shown in design  
Decorative applications: Black glass, Routing  
Handle: PS 10 – 1600mm





Flush or 3D applications



MODEL GL 03

Colour: RAL 9016  
 Glazing: Satinovo  
 Decorative applications: Black glass,  
 3D stainless steel  
 Handle: PS 10 – 1600mm



MODEL GL 04

Colour: RAL 7001  
 Decorative applications:  
 Black glass, Routing  
 Handle: PS 10 – 1200mm



MODEL GL 05

Colour: RAL 7016 / Woodec veneer  
 Glazing: Satinovo  
 Decorative applications:  
 Black glass, Routing  
 Handle: PS10 – 1400mm  
 painted with RAL 9005



MODEL GL 06

Colour: Montana veneer  
 Glazing: Sand-etched as shown in design  
 Decorative applications: Black glass  
 Handle: PQ10 40x20 - 600mm





28



MODEL 6115 PW

Colour: RAL 9007  
Handle: L- 1600mm, integrated  
with the panel, painted to match infill  
panel colour



MODEL 6116 PW

Colour: RAL 9016  
Glazing: Satinovo  
Handle: L-1600mm, integrated with  
the panel, painted to match infill panel colour



MODEL 6117 PW

Colour: RAL 7016  
Decorative applications: Routing  
Handle: L- 1600mm, integrated  
with the panel, painted to match infill  
panel colour





MODEL 6118 PW

Colour: RAL 7004  
Handle: PW23, L-1400mm  
stainless steel



MODEL 6120 PW

Colour: RAL 9016  
Decorative applications:  
Stainless steel, flush with surface  
Handle: L-1000mm, integrated  
with the panel, painted to match  
infill panel colour



MODEL 6121 PW

Colour: RAL 9006  
Decorative applications: Montana veneer  
Handle: L-1000mm, integrated  
with the panel, painted to match  
infill panel colour



MODEL 6119 PW

Colour: RAL 7016  
Decorative applications:  
Stainless steel, flush with surface  
Handle: L-1600mm, integrated with the panel,  
painted to match infill panel colour

In all PW models  
with integrated handles  
LED backlighting  
can be installed



MODEL 6124 PW

Colour: Decoral® Winchester  
heat-transfer film  
Decorative applications:  
Flush, painted RAL 9005  
Handle: integrated with the panel  
to match infill panel colour



*Stone is an expression of the beauty and strength of nature. No other material reflects the perfection of nature as stone does. Its irregular structure, surprising shapes, and rich palette of colours allow you to create unique, inimitable designs on your door.*



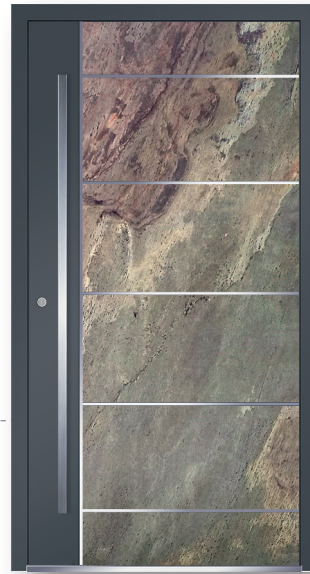

MODEL SL 02

Colour: RAL 7016 / natural stone MAKALU  
Decorative applications: 3D stainless steel  
Handle: PQ 40x20 L-1600mm

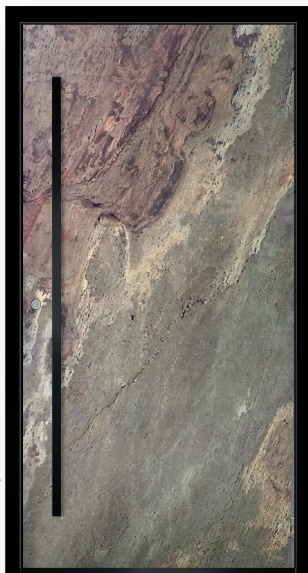

MODEL SL 01

Colour: natural stone MAKALU  
Handle: PQ 40x20 L-1600mm  
painted with RAL 9005





### MODEL SL 03

Colour: RAL 7016 / natural stone MAKALU  
 Glazing: Satinovo  
 Decorative applications:  
 3D stainless steel  
 Handle: PS 10 – 1400mm



### MODEL SL 04

Colour: natural stone ANNAPURNA  
 Glazing: Sand-etched  
 as shown in design  
 Decorative applications:  
 Metal painted to any RAL colour  
 Handle: PQ10 40x20 - 600mm







MODEL SL 06

Colour: RAL 7001 / natural stone EVEREST  
 Decorative applications:  
 3D stainless steel  
 Handle: PQ 40x20 L-600mm



MODEL SL 05

Colour: RAL 7016 / natural stone ANNAPURNA  
 Decorative applications: 3D stainless steel  
 Handle: PQ 40x20 L-1600mm  
 painted with RAL 9005



# CONCRETE EFFECT



MODEL BE 01

Colour: Architectural concrete  
Handle: PQ 40x20 -1600mm



MODEL BE 04 PW

Colour: Architectural concrete  
Handle: 1600mm integrated with the panel, painted with RAL 9005



MODEL BE 02

Colour: Architectural concrete  
Glazing: Satinovo  
Handle: PQ 40x20 L-1600mm painted with RAL 9005

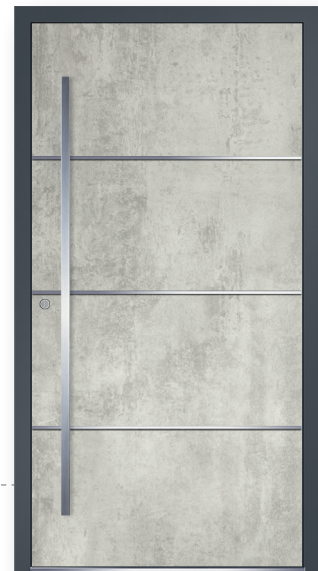

MODEL BE 03

Colour: Architectural concrete  
Decorative applications:  
3D stainless steel  
Handle: PQ10 40x20 -1600mm

*Architectural concrete makes  
for a modern and stylish door.  
“Minimalism and timeless design”.*





*The Retro Line means timeless designs with decorative details in classic style. Tradition and elegance are the qualities that will draw you into a tasteful interior.*



MODEL RL 01

Colour: RAL 9016  
 Glazing: Satinovo  
 Decorative applications:  
 Classic style aluminium frames  
 Handle: PS10 – 800mm

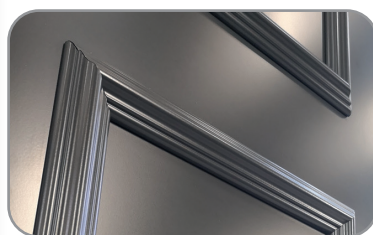

MODEL RL 02

Colour: RAL 7016  
 Decorative applications:  
 Classic style aluminium frames  
 Handle: PS10 – 800mm



MODEL RL 03

Colour RAL :9016  
 Decorative applications:  
 Classic style aluminium frames  
 Handle: PS10 – 800mm

## RETRO LINE



MODEL RL 04

Colour: RAL 7016  
Glazing: Satinovo  
Decorative applications:  
Classic style aluminium frames  
Handle: PS10 – 800mm



MODEL RL 05

Colour: RAL 9016  
Glazing: Satinovo  
Decorative applications:  
Classic style aluminium frames  
Handle: PS10 – 800mm



## THREE TYPES OF DOOR INFILL PANELS ARE AVAILABLE IN OUR OFFER:



### STANDARD INSERT PANEL:

These panels are mounted in the door frame in the same way as typical doors. The profile of the door is visible both from the inside and the outside. This is the simplest and easiest to install type of door infill, offered in thicknesses of 24 and 36 mm as standard.

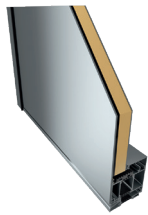

### SINGLE-SIDED ATTACHMENT PANEL:

These panels are made from aluminium skin layers. On the outward facing layer, a 3 mm-thick aluminium sheet is attached to the door frame, making it invisible, while on the inward-facing side, beading is applied. This construction gives doors an elegant and cohesive look.

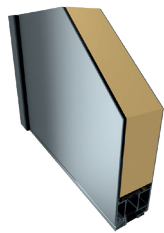

### DOUBLE-SIDED ATTACHMENT PANEL:

These panels provide the highest heat insulation parameters. Aluminium sheets cover the doors from both sides, ensuring elegance and refined aesthetics. The total thickness of the infill is greatest in this type of construction and is adapted to the particular type of door profile.

Our products can be used in all types of aluminium and PVC doors available on the market.

## GLASS

### Master-Carre

clear glass

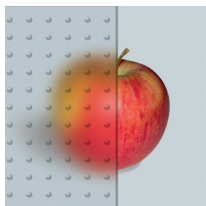

### Master-Point

clear glass

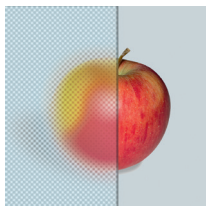

### Satinovo

milky glass

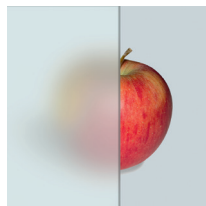

### Sand-etched as shown

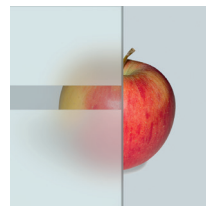

### Master-Ligne

clear glass



### Chinchilla

clear glass

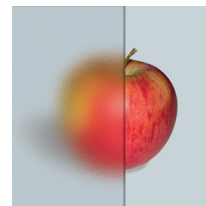

### Antisol

grey glass



### Antisol

brown glass



### Stopsol

grey glass

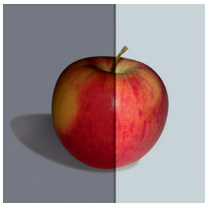

### Stopsol

brown glass

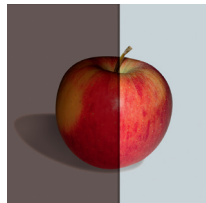

### One-way glass Mirrastar



### Transparent glass

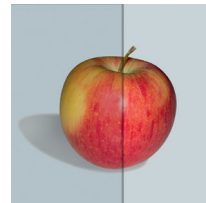

ROUND-PROFILE HANDLES

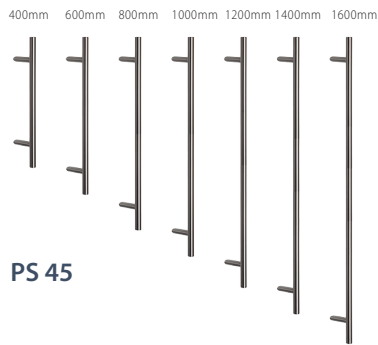
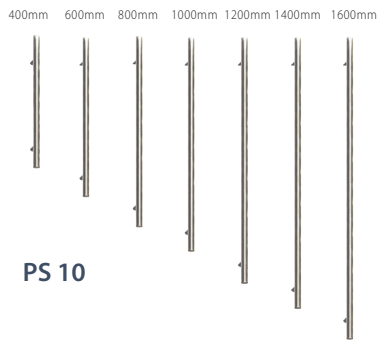

SQUARE-PROFILE HANDLES

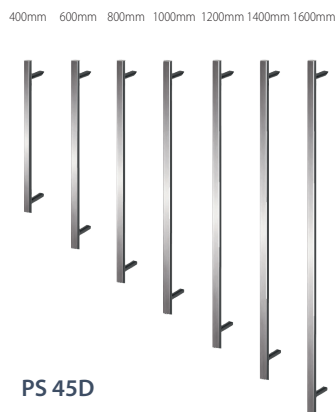
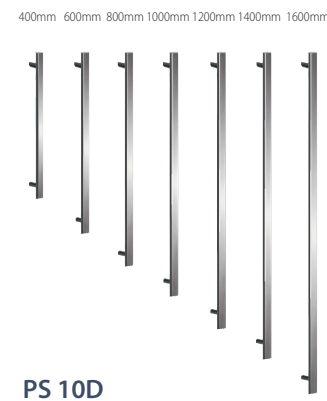

625mm 825mm 1025mm 1225mm 1425mm 1625mm



**PS 10CD**



**PS 20**



**PS 379711**  
315mm



**PQ WE 26**  
30x30mm  
available in the following lengths  
800, 1000, 1200, 1400,  
1600, 1800mm



**QA**  
available in the following lengths  
1800, 2000, 2200mm



**QS**  
40x20mm  
available in the following lengths  
1000mm

Handle colours:



Stainless steel

## INSET HANDLES



**PW 10**



**PW 10**  
with insert option



**PW 19**



**PW 21**



**PW 22**



**PW 25**



**PW 23**  
available in the following lengths 1400mm



**PW 58**



**PW 72**



**PW 72**  
with insert option



**PW 104**

Handle colours:



Stainless steel

**PWZ**  
integrated with the panel,  
custom length

Handle colours:



all available RAL colours

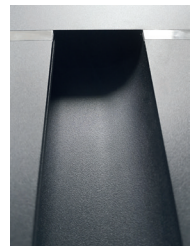

## DECORATIVE HANDLES



**PZ 29**



**PZ 31**



**PZ 44**



**PZ 45**



**PZ 76**



**PZ 83**

Handle colours:



Stainless steel



**PZ 77**



**PZ 82**



HANDLES WITH WOODEN ELEMENTS



All handles with wooden elements are available in four different varieties of wood: oak, jatoba, walnut, wenge

**PD 124**  
available in 1000 and 1200mm

**PD 125**  
available in 1000mm

**PD 134**  
available in 1200 and 1600mm

**PD 136**  
available in 1000 and 1200mm

HANDLES WITH ELECTRONICS

**E KEY PAPILLARY LINE READER**



available in handle models: PS10 and PS45



available in handle models: PQ10, PQ45

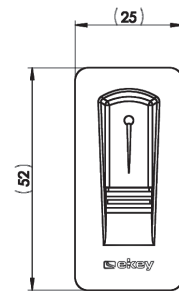

**IDENCOM PAPILLARY LINE READER**



available in handle models: PQ10 40x20, QS 40x20, PW10, PW72



available in handle models: PQ10 40x40 and QA

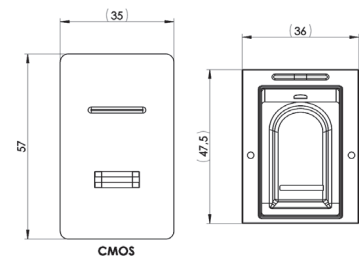

**MICROSWITCH IN HANDLE**



available in handle models: PS10, PS45, PD134



available in handle models: PQ10, PQ45, QA, PW10, PW21, PW22, PW72

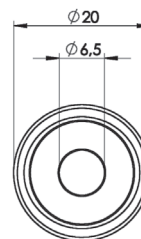

Available backlight colours:



# HANDLES WITH ELECTRONICS

## TOUCH SENSOR IN THE HANDLE



Available in handle models:  
PS10, PS45



Available in handle models:  
PQ10, PQ45, QA, PW10,  
PW21, PW22, PW72

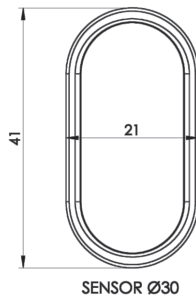

Available backlight colours:

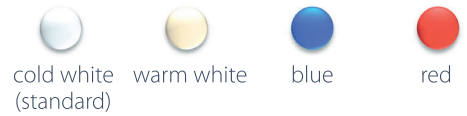

## TOUCH SENSOR IN THE HANDLE

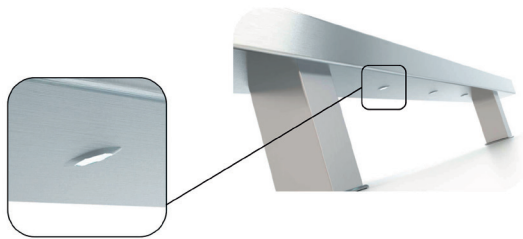

Available in handle models:  
PS10, PS45, PQ10, PQ45, PW10, PW21, PW22, PW72, QS, QA

Available backlight colours:



## PWZ HANDLE BACKLIGHTING



Available backlight colours:



## HANDLES WITH DIGITAL MINI-CAMERA AND INTERNAL, COLOURED LCD DISPLAY



**PE 2284**  
30x20x1200mm



**PE 2294**  
H - 1200mm

HANDLES

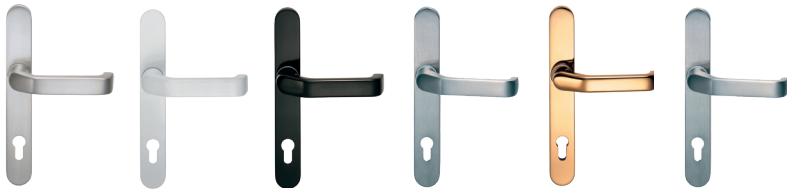

**370900**  
silver

**370902**  
white

**370904**  
brown

**370905**  
F9

**370907**  
gold

**370909**  
stainless steel

LETTERBOXES



**372180**



**372175**

STAINLESS STEEL BEZELS

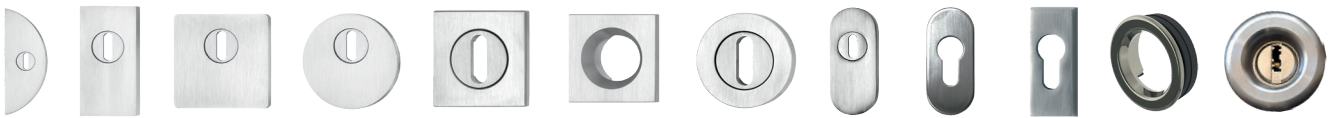

**60421**

**61421**

**64421**

**65421**

**74421**

**74422**

**78421**

**369846**

**370969**

**393882**

**RS 10**

**RS 20**

SCRATCH PROTECTION



**KS100**



**KS200**



**KS300**

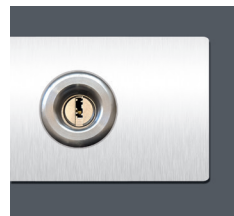

**KS400**



**KS400 BIOKEY**

KICK PLATES



Flush or surface mounted kick plate EK100    Flush or surface mounted kick plate EK200

Other designs available by request



ZenAluminium



[www.zenaluminium.pl](http://www.zenaluminium.pl)